



Design Version - GFK21B Blower Kit with Timer Control Module



WARNING

RISK OF FIRE AND ELECTRICAL SHOCK!

TURN OFF THE GAS AND ELECTRICAL POWER BEFORE INSTALLING BLOWER!

When installed, make sure to contain any excess wire of the cord set;
Preventing it from making contact with moving or hot objects.

DO NOT ATTEMPT TO INSTALL OR OPERATE IF YOU CANNOT READ OR UNDERSTAND THESE INSTALLATION INSTRUCTIONS

- Do NOT wire 110-120 VAC to gas control Valve
- Do NOT wire 110-120 VAC to wall switch - Incorrect wiring will damage millivolt values or override IPI safety lockout and may cause explosion

Drywall dust or other fragments may be present in your fireplace's vent space, clean this area before you install the blower kit. Any bearing or motor damage resulting from this condition is not covered by the warranty policy.

INTRODUCTION

A control module is provided with the blower kit which automatically turns the fan ON and OFF at preset times and is equipped with a Speed Button to provide a quiet air flow at the desired speeds.

GFK21B Blower Kit is designed for Gas Burning fireplaces and is connected to the IPI or Millivolt gas valve.

- The control module will turn ON the fan automatically 7 minutes after the main flame has been turned ON and turn the fan OFF automatically 12 minutes after the main flame has been turned OFF.
- The fan will turn ON at the last speed setting used and remain at that setting until changed.
- Press the FAN SPEED button to adjust the speed - RED light will indicate: HI, Medium HI, Medium LO, LO or OFF.

Power must be provided through an approved factory installed junction box from the hearth product's manufacturer.

BLOWER KIT CONTENTS - Fan Assembly affixed with dampening pad and velcro adhesive strips.

Control Module & Accessories- Not all items may be used.

- 1) Jumper Wire
See Figure: 5

- 2) Jumper Wire
& Ground Screw
See Figures: B1 & B2

- 3) FK-ESC Speed Module

- 4) Ground Wire
& Ground Screw

- 5) Jumper Wires for
Millivolt Valve

Red Jumper Wire
Heatlator-Heat & Glo-Quadra-Fire
Power Strip Style Junction Boxes

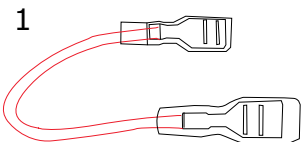

Red Jumper Wire
(For IPI Gas Valves)

Ground Screw

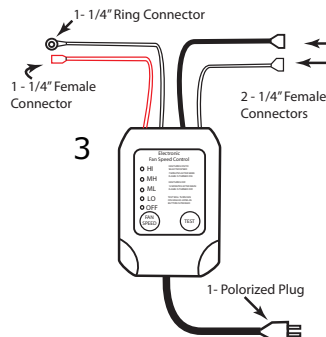
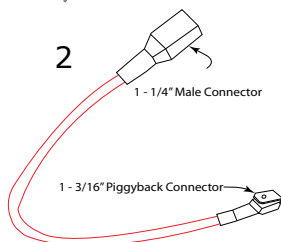

Ground Screw

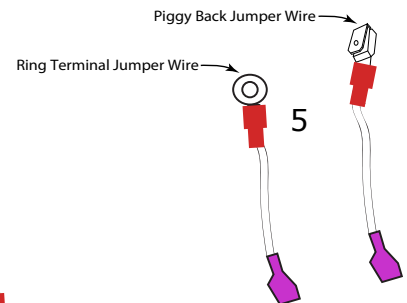
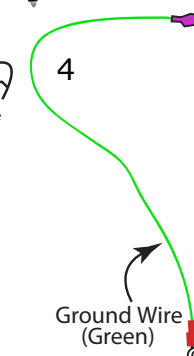



Step 1: Turn Off Fireplace and allow it to cool down. Disconnect from 120V Power. Shut off the Gas supply. Remove the louver which covers the lower vent space below the firebox.

Lay control module with wires extended out in a straight line, with the 2-Prong power plug furthest away from the fireplace.

Step 2: Push the Green Ground Wire disconnect onto the ground tab on the end of fan. (Figure: 1)

Connect White (Fan Neutral) and Black (Fan Hot) wires to either of the spade terminals attached to the motor. Push disconnects onto metal tabs. (Figure: 1)

Step 3: Under Firebox, wipe off the area where the Fan will be mounted, this will allow the velcro to take hold. Visualize a pathway for the blower to reach the back. Remove the clear backing of the velcro strips. (Figures: 2 , 3 & 8)

Hold blower assembly so fan blades face up. Slide blower assembly through bottom vent space; as the blower reaches the back - rotate blower, position blower parallel against back wall in center. The air exit port will face up and velcro strips will affix blower to back wall. (Figures: 2, 3 & 8)

Step 4: Insert the Jumper Wire into the two small ports in the lower corner of Junction Box. Below where 'FAN' is printed, one port is above the other. (Figures: 5 & 6)

Insert 2-Prong Plug into where 'FAN' is printed on the Junction Box. (Figures: 5 & 6)

If you have a different type of factory installed Junction Box, plug 2-Prong plug into a receptacle. (Figure: 7)

• Identify Gas Valve Type in fireplace: Millivolt or IPI Then, continue with Step 5.A(Millivolt) or 5.B(IPI)

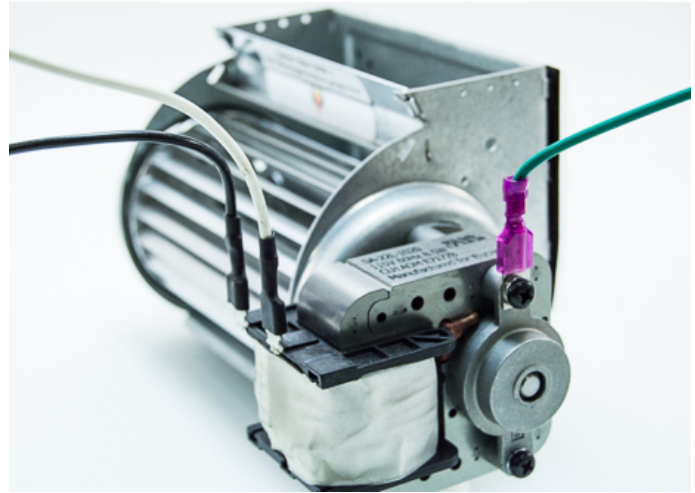

Figure: 1 • Does not matter which metal tab you connect the black and white wires to.

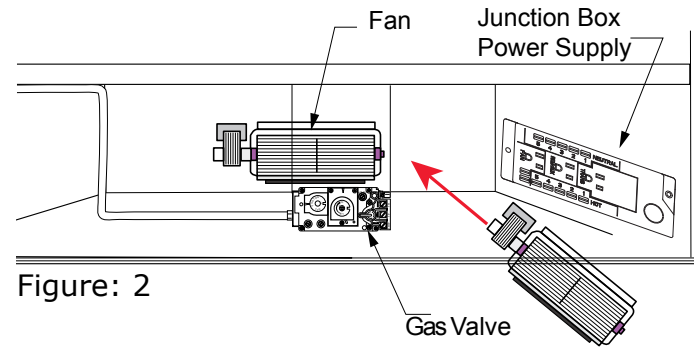

Figure: 2

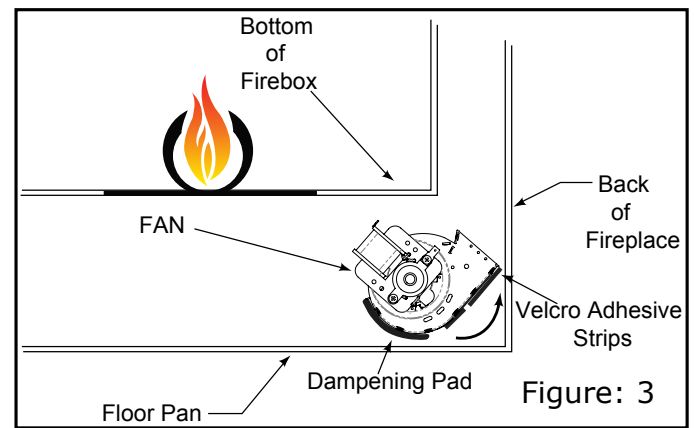

Figure: 3

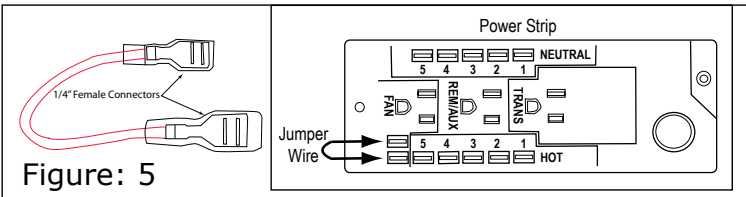

Figure: 5

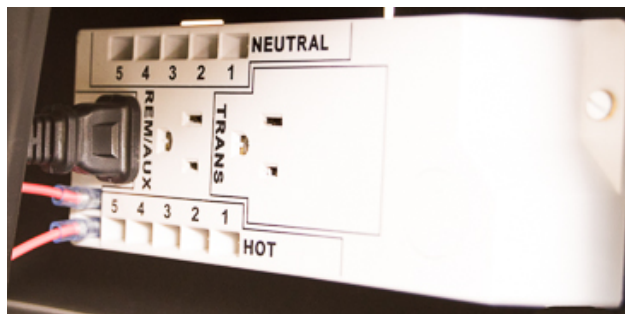

Figure: 6

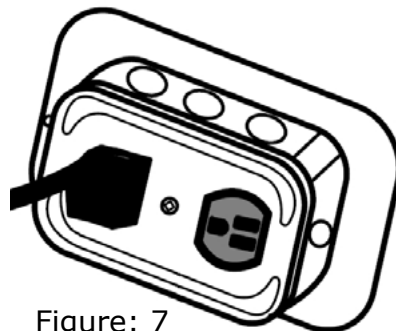

Figure: 7

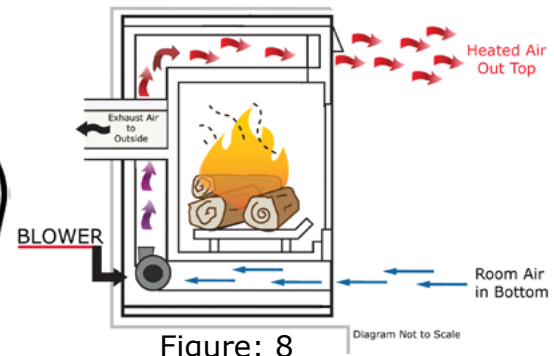

Figure: 8



5.A - Steps for connecting control module to Millivolt gas valve

Step 1) Check Millivolt Gas valve to confirm existing Thermopile wires are in correct location - Reposition if necessary.

- White wire must be at "TP".
- Red wire must be at "THTP".

(Figure: A1)

Step 2) • Connect Red (Sense +) wire to the "TH"
 • Connect Black (Sense -) wire to the "TP"

(Figure: A2 & A3)

- If existing wire is present at "TH", connect "White Jumper wire with ring terminal" to Red (Sense +) and secure at "TH".
- (Figure: A4)

Step 3) Ground ring terminal end of Green wire connected to fan onto metal frame of fireplace.

(Figure: A6)

Figure A5 illustrates the fan and control module positioning.
Figure A7 illustrates the wiring diagram for (5.A - Millivolt gas valve).

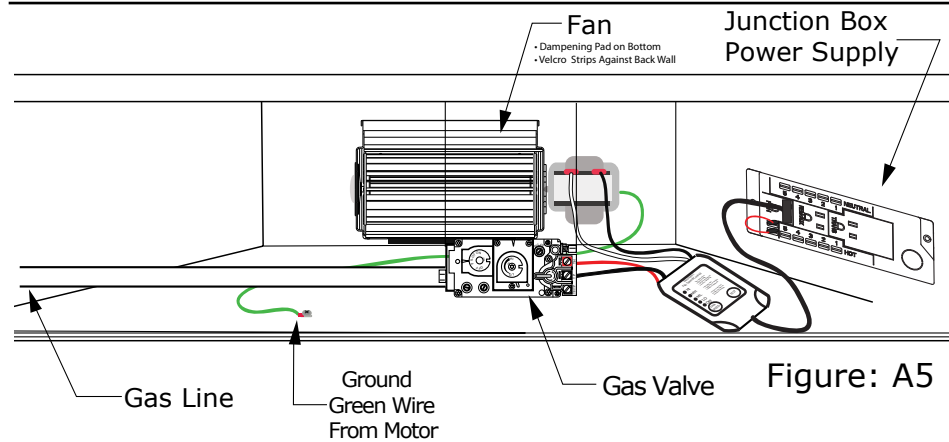

Figure: A6

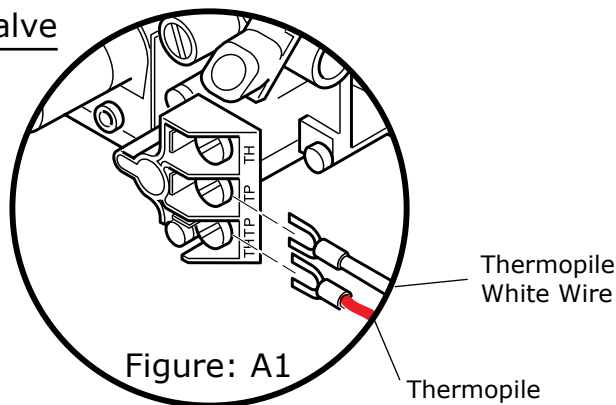

Figure: A1

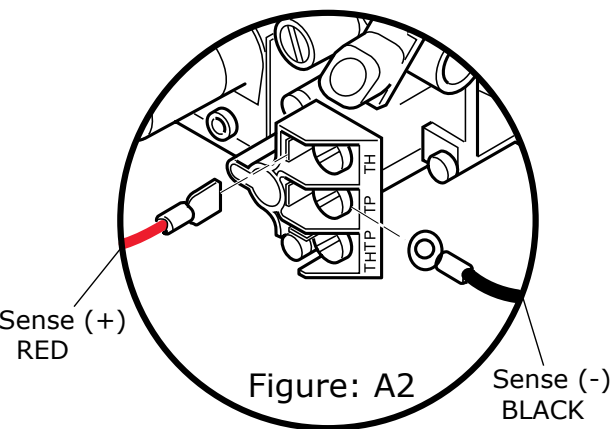

Figure: A2



Figure: A3



Figure: A4

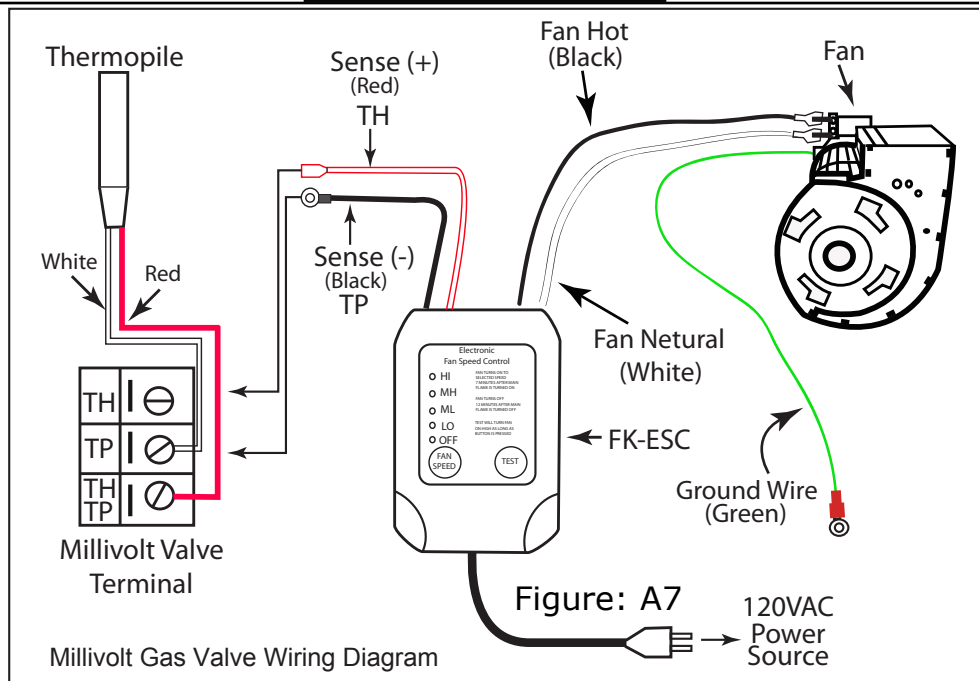

Figure: A7

WIRING NOTES: *This is a polarity sensitive system. Ensure you wire it exactly as shown in the diagram above. Thermopile wires must also be located with Red at TH/TP and White at TP on the gas valve.*

5.B - Steps for connecting Control Module to IPI gas valve

Step 1) Disconnect the 3/16" connector of the "MAIN" wire from main coil of gas valve.
(Figure: B1)

Step 2) Use 1/4 Inch male end of "Red Jumper with piggyback connector" and connect to Sense (+) RED wire.

Push female input of "Red Jumper with piggyback connector" onto spade where the "MAIN" wire was removed in Step 1.

Take "MAIN" wire connector from Step 1 and push onto male spade of "Red jumper with piggyback connector".
(Figures: B1, B2 & B6)

Step 3) Ground ring terminal of Sense (-) BLACK wire to metal frame of fireplace.
(Figure: B3)

Step 4) Ground ring terminal end of Green wire connected to fan onto metal frame of fireplace.
(Figure: B4)

Figure B5 illustrates the fan and control module positioning.
Figure B6 illustrates the wiring diagram for (5.B - IPI gas valve).

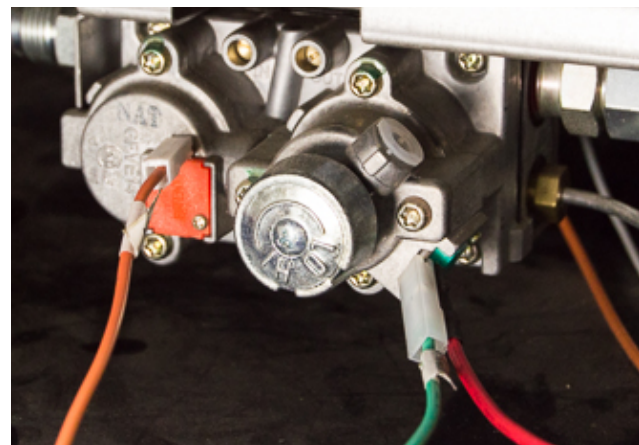
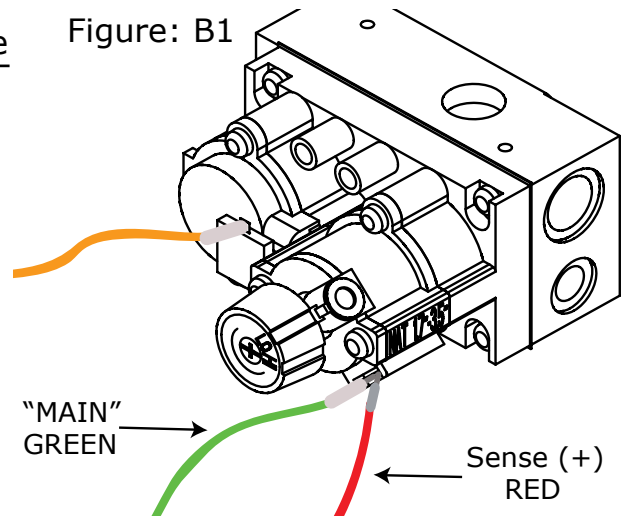

Figure: B2

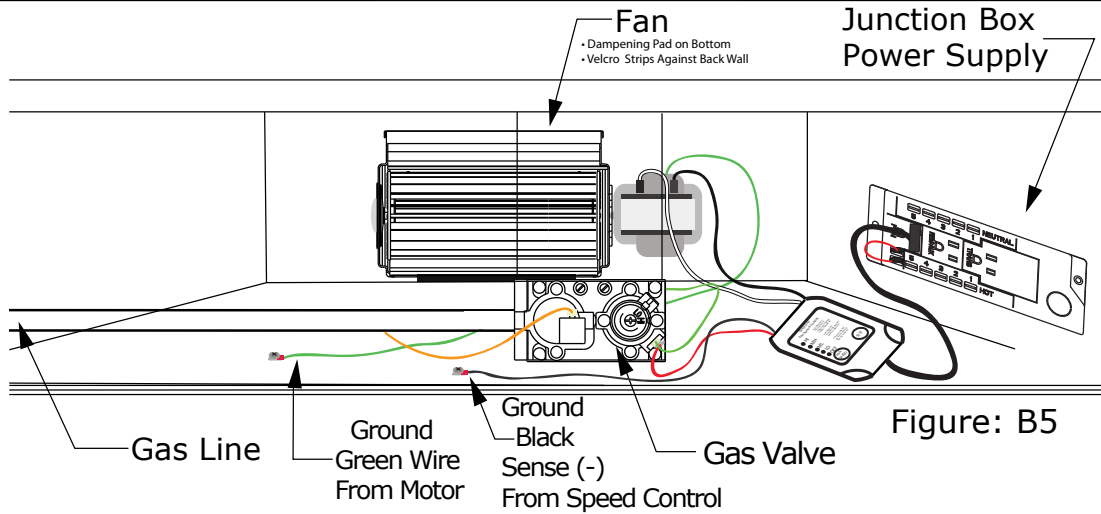

Figure: B5



Figure: B3



Figure: B4

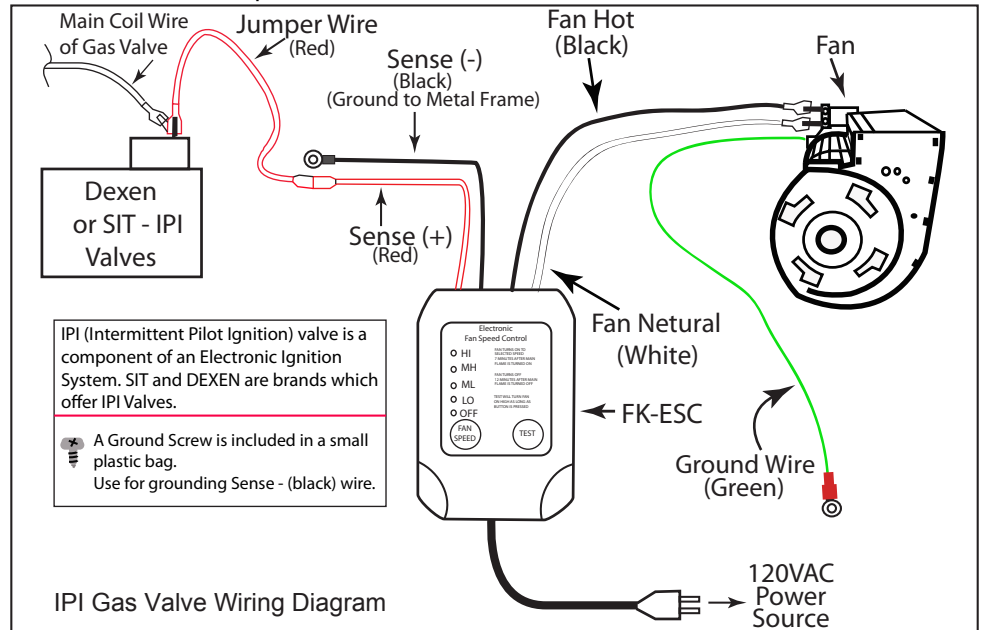

WIRING NOTES: *When wiring an IPI system the Sense (-) Black wire must be secured to a ground point on the metal frame of the appliance for proper operation.*

Figure: B6

Step 6) OPERATION

- To check the fan for proper wiring press the TEST button. This is a manual override that will operate the fan on HI as long as the button is depressed, it will return to normal operation after releasing the button.
- The FK-ESC speed control will turn the fan ON automatically 7-minutes after the main flame has been turned ON and turn the fan OFF automatically 12-minutes after the main flame has been turn OFF. There are four speeds, HI, Medium HI, Medium LO, LO and OFF. The factory default speed setting is HI upon initial use. You can manually adjust fan speed by pressing the FAN SPEED button; with each press of the button you can change the various fan speeds. The LED lights will allow you to visually see the fan speed you selected.
- The FK-ESC will remember the last setting used however it will always turn ON to the HI setting for 5-seconds then return to the last setting.



The fan will automatically turn ON 7 minutes after the fireplace has been turned ON.

The fan will automatically turn OFF 12 minutes after the fireplace has been turned OFF.

TROUBLE SHOOTING

• *Fan Won't Turn ON in 7-Minutes*

- a) Press the TEST button to ensure there is power to the fan. If no power is present, check the 120VAC outlet the Control Module is plugged into. Use a lamp or radio to ensure power is present. If no power is present, check circuit breaker or find another power source.
- b) If using the power strip jumper wire shown in Figures 5 & 6, ensure the jumper is installed properly allowing power to be supplied to the power strip.
- c) The Control Module is designed to operate with a Millivolt or IPI system. The operational specification for the Sense voltage is 50mVDC to 9VDC. It will not operate with a 24VAC gas valve system.

• *Fan Won't Turn OFF in 12-Minutes*

- a) Ensure ALL wires are properly secured and placed on the correct terminals of the gas valve(Figure: A7 or B6) This is a polarity sensitive system; if wires are reversed it will not turn OFF the fan.

MAINTENANCE

Cleaning on a semi-annual basis is required to keep the warranty in place. Dust or dirt must be removed from the fan blades, air inlets and blower outlet for the fan kit to maintain the efficiency of the system. Carefully use a vacuum with a brush to remove any dust. If unable to reach fan with a vacuum remove the fan from the appliance for easier cleaning.

TWO YEAR LIMITED WARRANTY of Control Module "FK-ESC" by SKYTECH

SKYTECH II warrants this FK-ESC speed control is two years or 24 months from the date of purchase or installation to the original owner. This warranty is NOT transferable to another person.

- Should any part fail because of defective workmanship or material from the original date of purchase SKYTECH II will repair or replace the part at SKYTECH II option.
- Damage to the FK-ESC caused by accident, misuse, abuse, or installation error, whether by a contractor, service company, or owner is not covered by this warranty. Modification of the Fan System will void the warranty.
- The owner must provide a bill of sale, cancelled check or a payment record should be kept to verify purchase date and establish warranty period. SKYTECH II is not responsible for: Travel expenses, Diagnostic costs, and Service labor to repair the defective Fan system. Freight charges will not be covered on warranty parts or Fan systems.
- This warranty does not cover claims, which do not involve defective workmanship or materials.
- IN NO EVENT SHALL SKYTECH II BE LIABLE FOR INCIDENTAL AND CONSEQUENTIAL OCCURRENCES, INCLUDING THE IMPLIED WARRANTIES OR MERCHANTABILITY AND FITNESS, ARE LIMITED TO THE DURATION OF THE THIS WRITTEN WARRANTY. THIS WARRANTY SUPERSEDES ALL OTHER ORAL OR WRITTEN WARRANTIES.
- Some states do not allow the exclusion or limitation of incidental and consequential damages or limitation on how long an implied warranty lasts, so the above limitation may not apply to you. This warranty gives you specific rights and you may have other rights, which vary from state, province, and nation. Warranty claims process will start with all information; SKYTECH II will reserve the right to physically inspect the product for defects, by authorized representatives.

FOR FK-ESC(Control Module) TECHNICAL INFORMATION CONTACT:	Skytech Products Group 9230 Conversation Way Ft. Wayne, IN 46809	1-(888) 672-8929 www.skytechsystem.com
---	--	---

My Fireplace Blower LLC produces and sells aftermarket fireplace blower kits; which require consultation of an Owner's Installation Manual from the Manufacturer of a particular fireplace model number for installation. During Installation of a fireplace blower kit or replacement blower, refer to the Owner's Installation Manual for your particular fireplace model to obtain supplemental information. My Fireplace Blower LLC is not responsible for any damage incurred during installation or resulting from installation of a fireplace blower kit, which was directed and/or conducted from the information within this document.

Installations in Canada must conform to the current CAN/CGAB-419.1 and .2 Gas Installation Code and local regulations. When installing the blower fan kit, it must be electrically grounded in accordance with CSA C22.1 Canadian Electrical Code Part 1 and/or Local Codes.

Installations in the USA must conform to local codes, or in absence of local codes or the National Fuel Gas Code, ANSI Z223.1-1988. When installing the blower fan kit, it must be grounded in accordance with local codes, or in absence of local codes, with the National Electrical Code, ANSI/NFPA 70-1987.