



Instructions for FK4 Blower Kit with Cord Set



WARNING

RISK OF FIRE AND ELECTRICAL SHOCK!

TURN OFF THE GAS AND ELECTRICAL POWER BEFORE INSTALLING BLOWER!

When installed, make sure to contain any excess wire of the cord set; Preventing it from making contact with moving or hot objects.

Drywall dust or other fragments may be present in your fireplace's vent space, clean this area before you install the blower kit. Any bearing or motor damage resulting from this condition is not covered by the warranty policy.

This Blower Kit is tested and safe when installed in accordance with these installation instructions. It is your responsibility to read all instructions and consult the Owner's Installation Manual for your particular model number for Supplemental Information before starting installation. Blower operates on 120V/60Hz power.

Blower Kit Parts

Check the contents of the carton.
Make sure nothing was damaged in shipment.
Do NOT install a damaged blower kit!

Description	Qty.
Fan	1
Thermodisc / Heat Sensor	1
Variable Speed Control	1
Cord Set	1
Velcro Strip	3
Foam Dampening Pad	1
Installation Instructions (Downloadable)	1

Step 1: Turn Off Fireplace and allow it to cool down. Disconnect from 120V Power. Shut off the Gas supply. Remove the louver which covers the lower vent space below the firebox.

Lay cord set out in a straight line, with the 3-Prong Power Plug furthest away from the fireplace.

Step 2: Push the green wire disconnect onto the ground tab on the end of fan. (Figure: 1)

Connect white and black wires of the cord set to either of the spade terminals attached to the motor. Push disconnects onto metal tabs (Figure: 1)

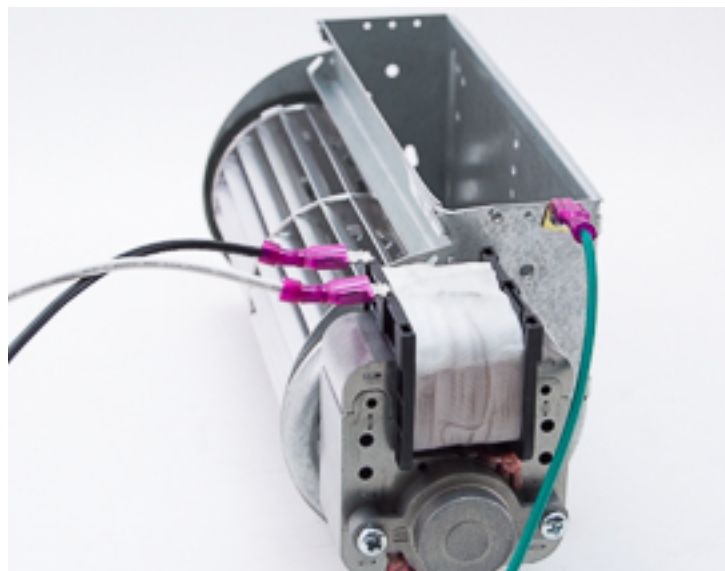

Figure: 1



Step 3: Under Firebox, wipe off the area where the Fan will be mounted, this will allow the velcro to take hold. (Figures: 3&4) Visualize a pathway for the blower to reach the back. Remove the clear backing of the velcro strips. (Figure: 3)

Hold fan assembly so the fan blades face up and fan motor is furthest away from fireplace. (Figure: 3)

Slide blower assembly through bottom vent space; as the blower reaches the back, position blower parallel with the back wall and rotate blower, so the blower's rectangle air exit port is facing up. (Figure: 4 & 8)

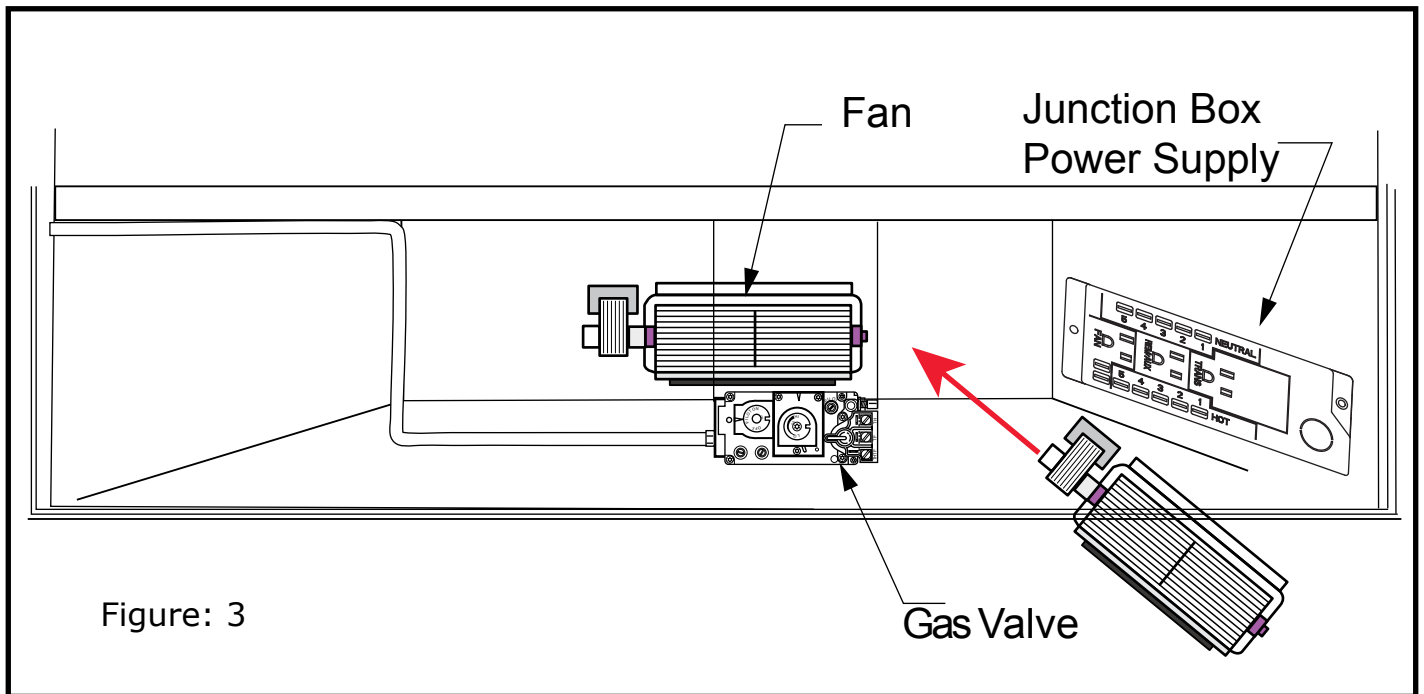

Figure: 3

Step 4: Place magnetic thermodisc to the warmest spot on the underside of the firebox (You may have to change the position of the thermodisc until you find a hot spot). (Figure: 5)

The thermodisc will activate the blower when it senses 120°F and will automatically turn the blower off after the fireplace cools below 90°F.

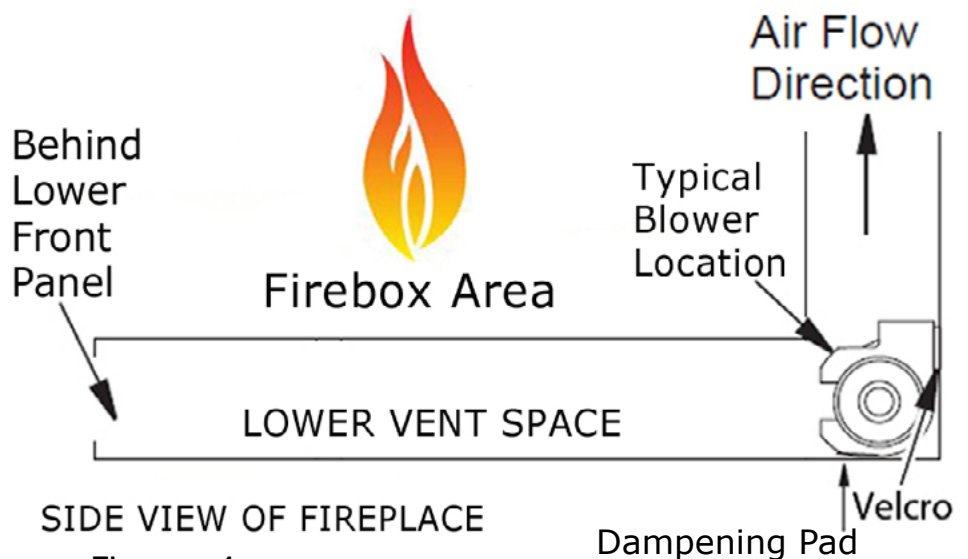

Figure: 4



Step 5: The Variable Speed Control may simply be set on the floor of the lower vent space near the front. A Velcro Strip is attached to the speed control for mounting, a good place could be on the side near the front. Turn the dial to the left and it will click off, turn right to reduce speed. (Figures: 5&8)

You may want to wait and run blower a few times to see where you would like to mount the variable speed control. The speed control must be in the ON position in order for the blower to run.



Figure: 5

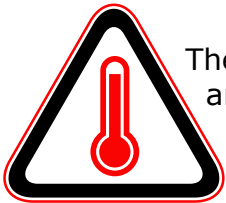

The fan will not run until the Thermodisc / Heat Sensor reaches approximately 120°F and the Variable Speed Control is turn to the "ON" Position! This means the Heat Sensor must be in contact with a hot spot on the underside of the Firebox.

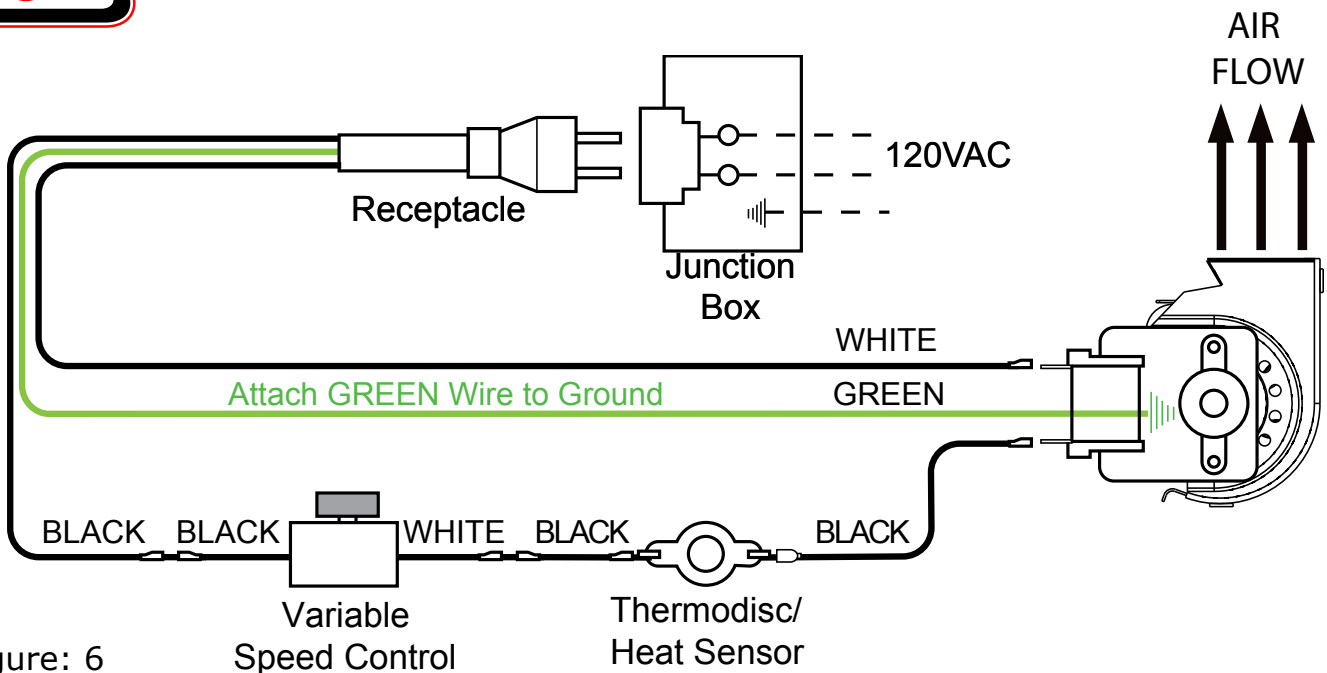

Figure: 6



Step 6:

Insert 3-Prong Plug into the Junction Box.
(Figure: 7)

- Wiring Diagram for this Blower Kit is illustrated in Figure: 6.

Finishing Steps:

If appliance is connected to a gas supply, turn it back on.

If Appliance is connected to 120 Volt Power, turn it back on.

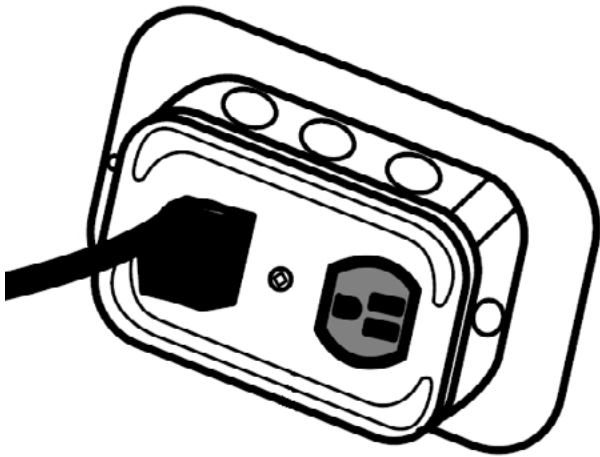

Figure: 7

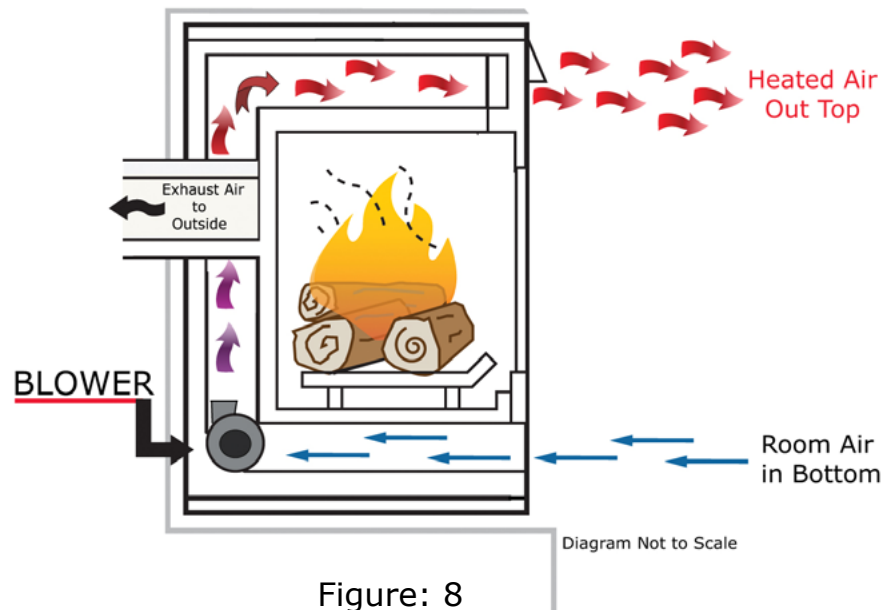

Figure: 8

My Fireplace Blower LLC produces and sells aftermarket fireplace blower kits; which require consultation of an Owner's Installation Manual from the Manufacturer of a particular fireplace model number for installation. During Installation of a fireplace blower kit or replacement blower, refer to the Owner's Installation Manual for your particular fireplace model to obtain supplemental information. My Fireplace Blower LLC is not responsible for any damage incurred during installation or resulting from installation of a fireplace blower kit, which was directed and/or conducted from the information within this document.

Installations in Canada must conform to the current CAN/CGAB-419.1 and .2 Gas Installation Code and local regulations. When installing the blower fan kit, it must be electrically grounded in accordance with CSA C22.1 Canadian Electrical Code Part 1 and/or Local Codes.

Installations in the USA must conform to local codes, or in absence of local codes or the National Fuel Gas Code, ANSI Z223.1-1988. When installing the blower fan kit, it must be grounded in accordance with local codes, or in absence of local codes, with the National Electrical Code, ANSI/NFPA 70-1987.