



Instructions for Design Version - FK12 Blower Kit



WARNING

RISK OF FIRE AND ELECTRICAL SHOCK!

TURN OFF THE GAS AND ELECTRICAL POWER BEFORE INSTALLING BLOWER!

When installed, make sure to contain any excess wire of the cord set; Preventing it from making contact with moving or hot objects.

Drywall dust or other fragments may be present in your fireplace's vent space, clean this area before you install the blower kit. Any bearing or motor damage resulting from this condition is not covered by the warranty policy.

This Blower Kit is tested and safe when installed in accordance with these installation instructions. It is your responsibility to read all instructions and consult the Owner's Installation Manual for your particular model number for Supplemental Information before starting installation. Blower operates on 115V/60Hz power.

Blower Kit Parts

Check the contents of the carton.
Make sure nothing was damaged in shipment.
Do NOT install a damaged blower kit!

Description	Qty.
Fan	1
Power Cord	1
Dampening Pad	1
Velcro Strip	3
Installation Instructions (Downloadable)	1

Step 1: Turn Off Fireplace and allow it to cool down. Disconnect from 120V Power. Shut off the Gas supply. Remove the louver which covers the lower vent space below the firebox.

Lay cord set out in a straight line, with the 3-Prong Power Plug furthest away from the fireplace.

Step 2: Push the green wire disconnect onto the ground tab on the end of fan. (Figure: 1)

Connect white and black wires of the cord set to either of the spade terminals attached to the motor. Push disconnects onto metal tabs. (Figure: 1)

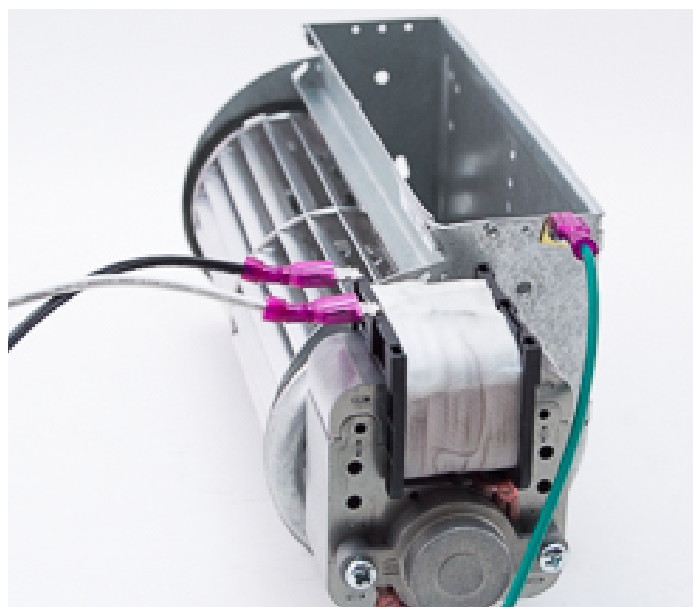
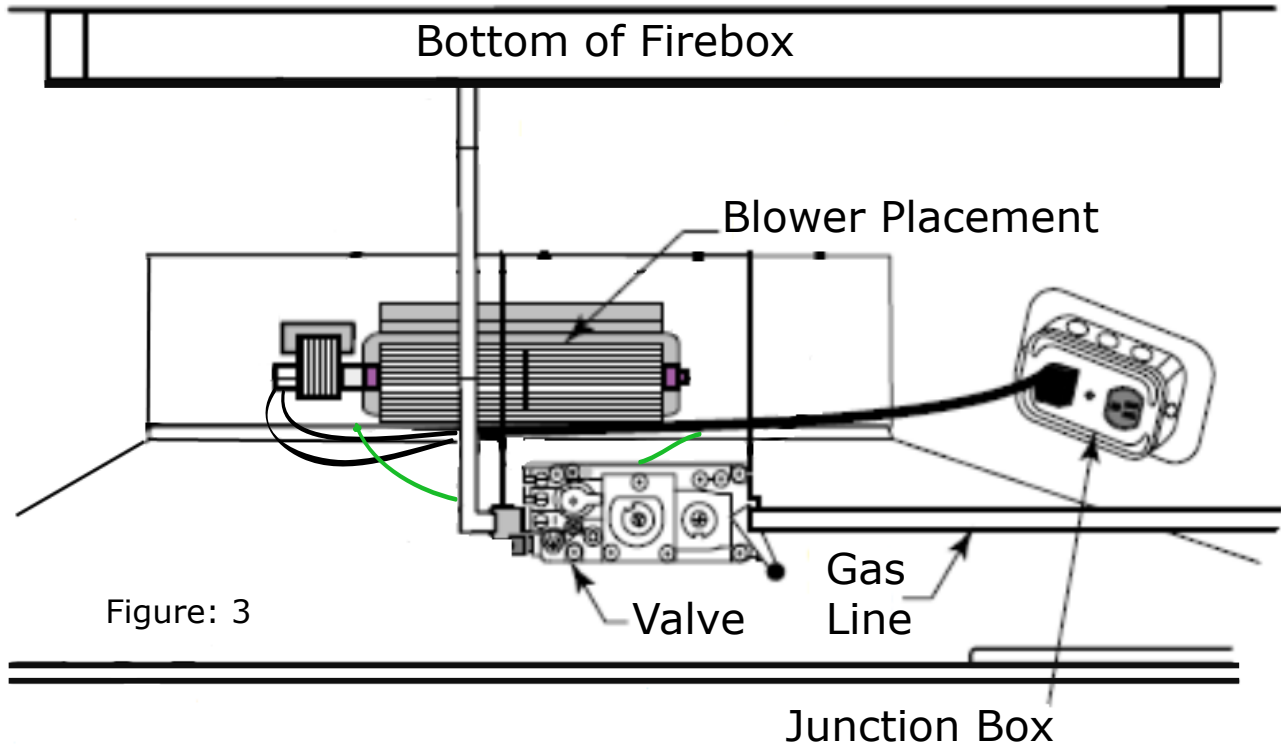

Figure: 1 •Does not matter which metal tab you connect the black and white wires to.



- For Models SC36/42 and others with a lower front vent access grill / louver, go to Step 3.
- For Models BC36/42, TL36/42, UVBC36/42, VL33, NVBC36/42 and UVSRC36/42, go to Step 4
- For Models SC36/42 and others with a lower front vent access grill / louver, go to Step 3.
- For Models BC36/42, TL36/42, UVBC36/42, VL33, NVBC36/42 and UVSRC36/42, go to Step 4.



Step 3: Under Firebox, wipe off the area where the Fan will be mounted, this will allow the velcro to take hold.
(Figures: 3&4)

Visualize a pathway for the blower to reach the back. Remove the clear backing of velcro strips. (Figure: 3)

Hold fan assembly so the fan blades face up and fan motor is furthest away from fireplace.

Slide blower assembly through bottom vent space; as blower reaches the back, position blower parallel with the back wall and rotate blower, so the blower's rectangle air exit port is facing up.
(Figures: 2, 3 & 4)

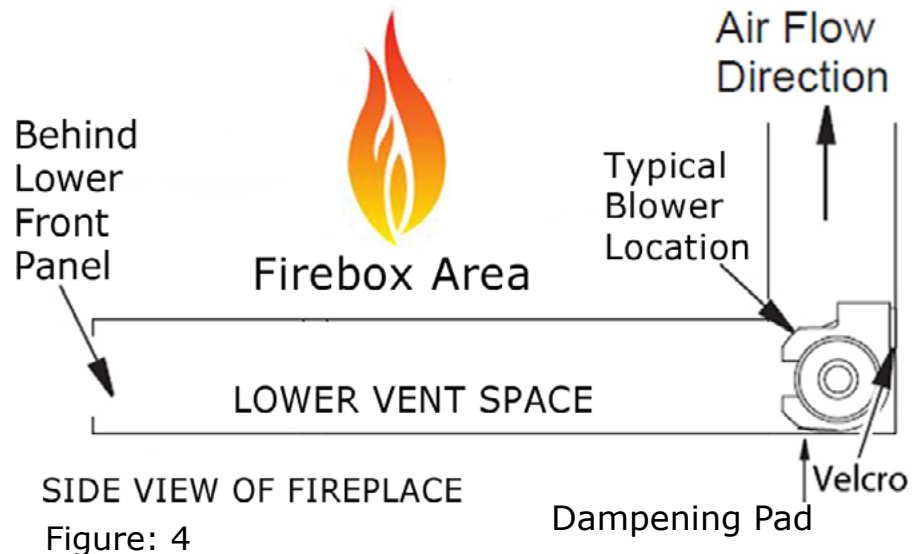



Step 4: Refractory Brick and Access Panel Removal. If your fireplace has glass doors, it is recommended that doors and the lower track be removed for easier access.

Models BC36/42, TL36/42, UVBC36/42, VL33:

Remove the Refractory Brick by carefully lifting it out of the fireplace. Next, remove the access panel by carefully pulling up and out from the back middle edge of the panel until the tabs at each side are free. Use caution — the panel edges may be sharp. (Figure: 5)

Models NVBC36/42 and UVSRC36/42:

Remove the 2 Refractory Brick panels by carefully lifting them out of the fireplace. Next, remove the access panel by pulling it up and out from the side edge of the panel. Use caution — the panel edges may be sharp. (Figure: 5)

•Go to Step 3 to install fan.

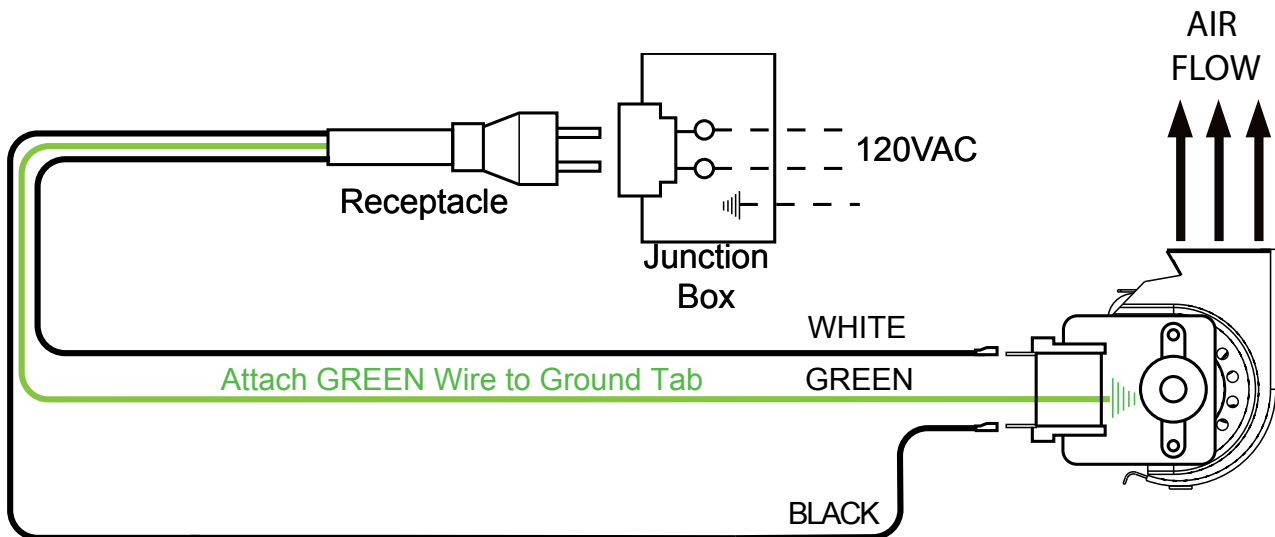
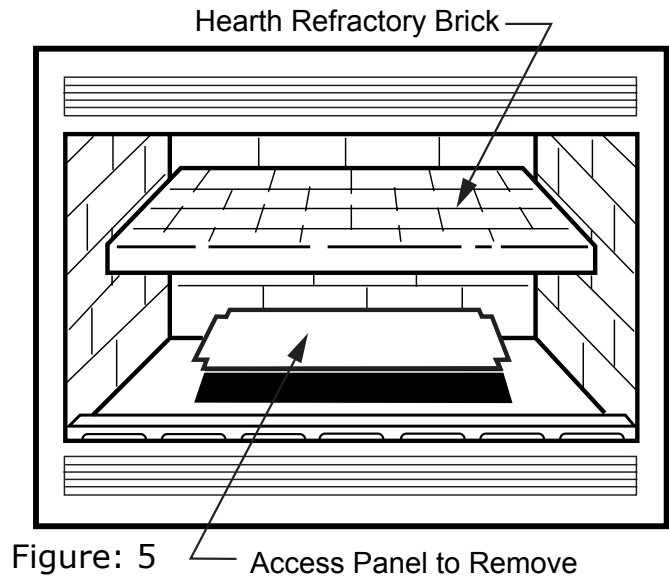
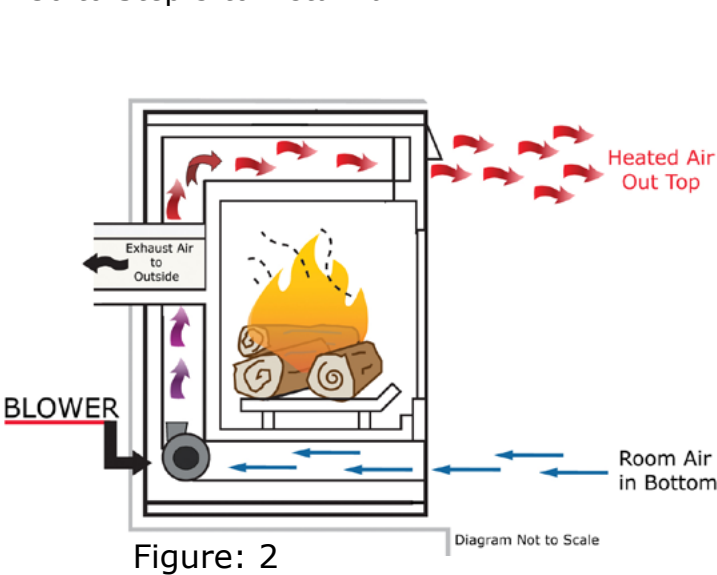

•Does not matter which metal tab you connect the black and white wires to.



Step 5: Insert the plug into the Junction Box / power receptacle located on the lower right or left side of the lower vent space. (Figures : 3&7)

(Caution: Make sure no wires are pinched.)

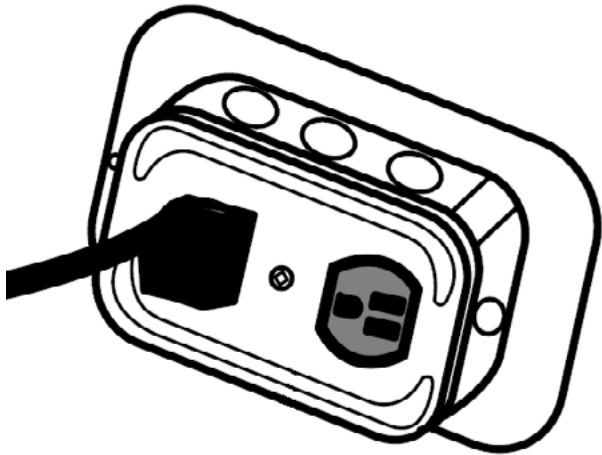

Figure: 7

•Wiring Diagram for this Blower Kit is illustrated in Figure: 6.

Finishing Steps:

If appliance is connected to a gas supply, turn it back on.

If Appliance is connected to 120 Volt Power, turn it back on.

Prior to reinstalling the access panel and the refractory brick, it is advisable to operate the wall switch on and off to assure fan operation.

Reinstall the access panel and refractory brick by reversing Step 4.

My Fireplace Blower LLC produces and sells aftermarket fireplace blower kits; which require consultation of an Owner's Installation Manual from the Manufacturer of a particular fireplace model number for installation. During Installation of a fireplace blower kit or replacement blower, refer to the Owner's Installation Manual for your particular fireplace model to obtain supplemental information. My Fireplace Blower LLC is not responsible for any damage incurred during installation or resulting from installation of a fireplace blower kit, which was directed and/or conducted from the information within this document.

Installations in Canada must conform to the current CAN/CGAB-419.1 and .2 Gas Installation Code and local regulations. When installing the blower fan kit, it must be electrically grounded in accordance with CSA C22.1 Canadian Electrical Code Part 1 and/or Local Codes.

Installations in the USA must conform to local codes, or in absence of local codes or the National Fuel Gas Code, ANSI Z223.1-1988. When installing the blower fan kit, it must be grounded in accordance with local codes, or in absence of local codes, with the National Electrical Code, ANSI/NFPA 70-1987.